

COORDINATING MOLDINGS

for

HOMECREST
Cascade WATERPROOF FLOORING

Slim Trim

For Laminate Floors Up to 3/4" (19 mm)
 3-in-1: Reducer, T-Molding, & End Cap



Moisture Proof Quarter Round



Moisture Proof T-Molding



Moisture Proof Reducer



Versatrack Shim

Used with Versatrack For Flooring 3/8-1/2" (9.5-12.7 mm)
 Optional Use with Reducer, T-Molding, & End Cap



VersaEdge Extra Tall

Stair Nose - 1.5" Height



Quarter Round



Moisture Proof End Cap



Versatrack

For Flooring 1/4-3/8" (6-9.5 mm)
 Optional Use with Reducer, T-Molding, & End Cap



Slim Cap

End Cap



All Moldings are 94" Long

Technical Information

Slim Cap

Moisture Proof
Surface Material: High Wear Resistant Aluminum Oxide Laminated
Core Material: PVC

SlimTrack
 Included with Slim Cap
Material: Cold Roll Steel.

Versatrack Shim
 Included with Slim Cap

SlimTrim

Functions as a Reducer, T-Molding, and End Cap.
Surface Material: High Wear Resistant Aluminum Oxide Laminated
Core Material: PVC

Dowel

To be used with Slim Trim for floors up to 3/4" (19mm).
Material: Polystyrene

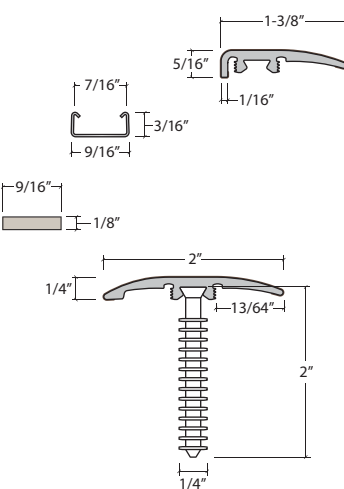

SLIM TRIM APPLICATIONS

NOTE: Dowel installation cannot be used on radiant heat floors.

1 Reducer:
 Up to 3/4" (19mm)

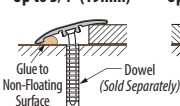

2 Transition:
 Up to 3/4" (19mm)

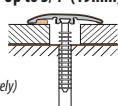

3 End Cap: (Hard Surface to Carpet)

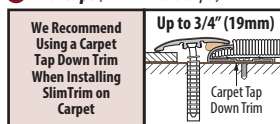

VersaEdge Extra Tall

The VersaEdge Stair Nose combines style and function to enhance the beauty of a staircase or step. For use on flooring with an overall thickness of up to 0.75" (19 mm).

Surface Material: High Wear Resistant Aluminum Oxide Laminated
Core Material: Aluminum

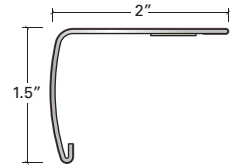

VERSAEDGE APPLICATIONS

"Lock-Down" Install (e.g. Stair Treads)

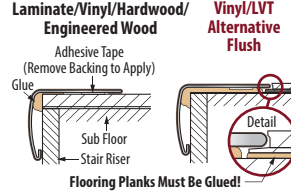

"Floating" Install

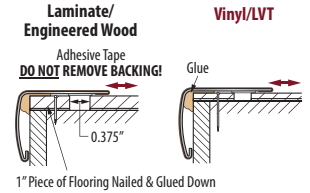

Moisture Proof Reducer

Reducers are used to transition from laminate flooring to floors of different height with a minimum height difference of 1/4".

Surface Material: High Wear Resistant Aluminum Oxide Laminated
Core Material: Exterior Grade Composite Wood Product

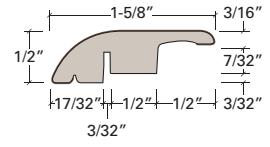

REDUCER APPLICATIONS

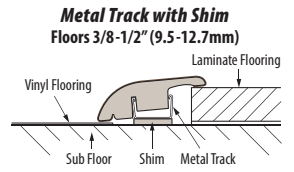
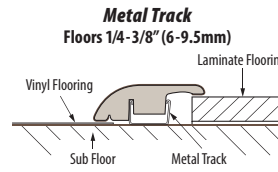

Moisture Proof T-Molding

T-Moldings are commonly used in doorways to join two laminate floors in adjoining rooms. Also recommended when making a transition from laminate floor to another floor that is approximately the same height.

Surface Material: High Wear Resistant Aluminum Oxide Laminated
Core Material: Exterior Grade Composite Wood Product

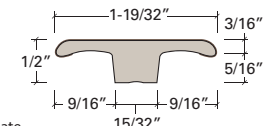

T-MOLDING APPLICATIONS

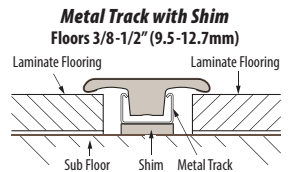
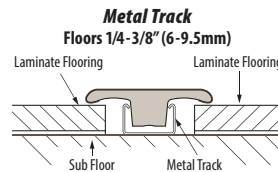

Moisture Proof End Cap

End Caps are used to transition from laminate to carpet, masonry (fireplaces), sliding doors and other exterior door jambs.

Surface Material: High Wear Resistant Aluminum Oxide Laminated
Core Material: Exterior Grade Composite Wood Product

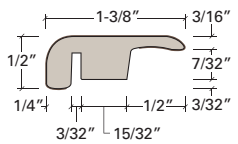

END CAP APPLICATIONS

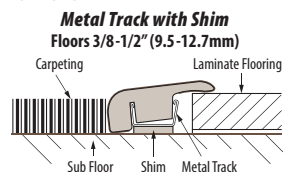
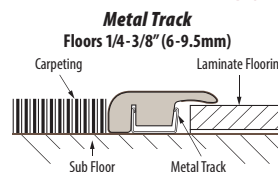

Quarter Round (Standard or Moisture Proof)

Quarter Rounds are used to conceal the required expansion space between the wall and the laminate flooring. Comes as standard MDF or moisture proof.

Surface Material: Decorative Paper
Core Material: Quarter Round: Standard MDF. Moisture Proof Quarter Round: Exterior Grade Composite Wood Product

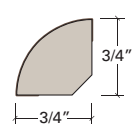

FOR MORE DETAILED INSTALLATION INFORMATION, TIPS, AND ADVICE GO TO: INSTALLATIONADVICE.COM